

Lexium 28 & Motors

Lexium 28 servo drives and
BCH2 servo motors

Catalog

October 2018



Quick access to Product information

Select your Catalog, your Training

Digi-Cat

The complete digital catalog for industrial automation



Makes your choice easy every day, everywhere!



With just 3 clicks, you can reach the 7,000 pages of the Industrial Automation & Control catalog, in both English and French.

- Digi-Cat is available on a USB key (for PC). To get your Digi-Cat, please contact your local center
- Download Digi-Cat from this address:

<http://digi-cat.schneider-electric.com/download.html>

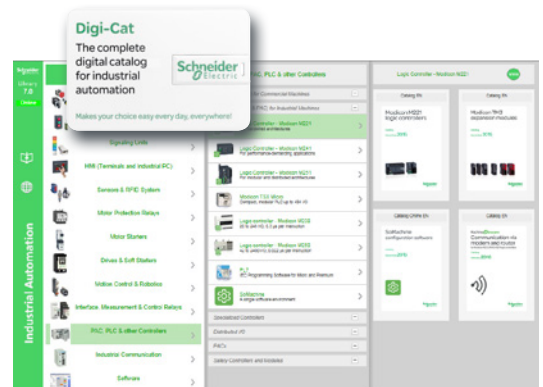

Find your training

- Find the right training for your needs
- Locate the training center with the selector tool, using this address:

<http://www.schneider-electric.com/b2b/en/services/training/technical-training.jsp>

then click on

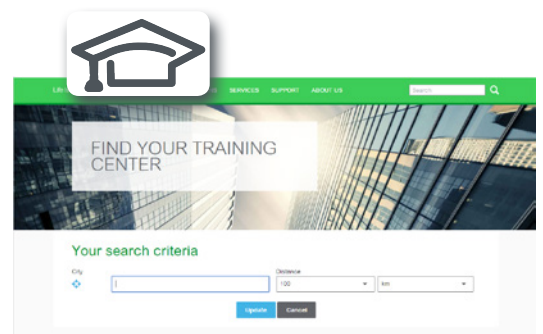
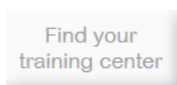

Life Is On



General content

Lexium 28 & Motors

Lexium 28 servo drives and BCH2 servo motors

■ General overview	
- Empowering industrial OEMs for the digital era	page 2
- Lexium 28 & BCH2: optimized servo bundles for compact machines.....	page 3
- Intuitive commissioning & programming.....	page 3
■ Lexium 28 servo drives	
- Applications.....	page 4
- Functions.....	page 5
- Embedded safety function STO.....	page 5
- Combinations: Lexium 28 servo drives and BCH2 servo motors.....	page 6
- Description.....	page 7
- References, dimensions and weights.....	page 8
■ Connection accessories, accessories	
- References.....	page 9
■ Configuration tools	
□ SoMove Setup software	
- Presentation, references.....	page 10
□ Multi-loader configuration tool	
- Presentation, references.....	page 10
■ Internal and external braking resistors	
- Presentation, references.....	page 11
■ Communication	
□ CANopen and CANmotion fieldbus	
- Presentation, references.....	page 12
□ EtherCAT fieldbus	
- Presentation, references.....	page 13
■ Additional EMC input filters for servo drives	
- Presentation, references.....	page 14
■ Motor starters	
- Presentation, combination.....	page 15
■ Protection using fuses	
- Combination.....	page 15
■ BCH2 servo motors	
- Presentation.....	page 16
- Description.....	page 17
- References.....	page 17
- Dimensions, weight.....	page 18
■ Options for BCH2 servo motors	
□ Integrated holding brake	
- Presentation, references.....	page 19
□ Integrated encoder	
- Presentation.....	page 19
■ Connection components	
- References: power cordsets, connector kits.....	page 20
- References: encoder cordsets, connector kits.....	page 21
- Selection of connector kit according to BCH2 motor type.....	page 21
■ Index	
- Product reference index.....	page 22

Empowering industrial OEMs for the digital era

To be competitive in today's digital era, machine builders must be innovative. Smart machines, those that are better connected, more flexible, more efficient, and safe, are enabling machine builders to innovate in ways never before possible.

- > EcoStruxure™ Machine, our open, interoperable, IoT-enabled system architecture helps you build smarter machines and equipment faster, making your business more efficient, profitable, and sustainable.
- > EcoStruxure Machine brings together key technologies for product connectivity and edge control on premises, and cloud technologies to provide analytics and digital services.
- > EcoStruxure Machine helps you bring more innovation and added value to your customers throughout the entire machine life cycle

Lexium 28 is part of EcoStruxure Machine

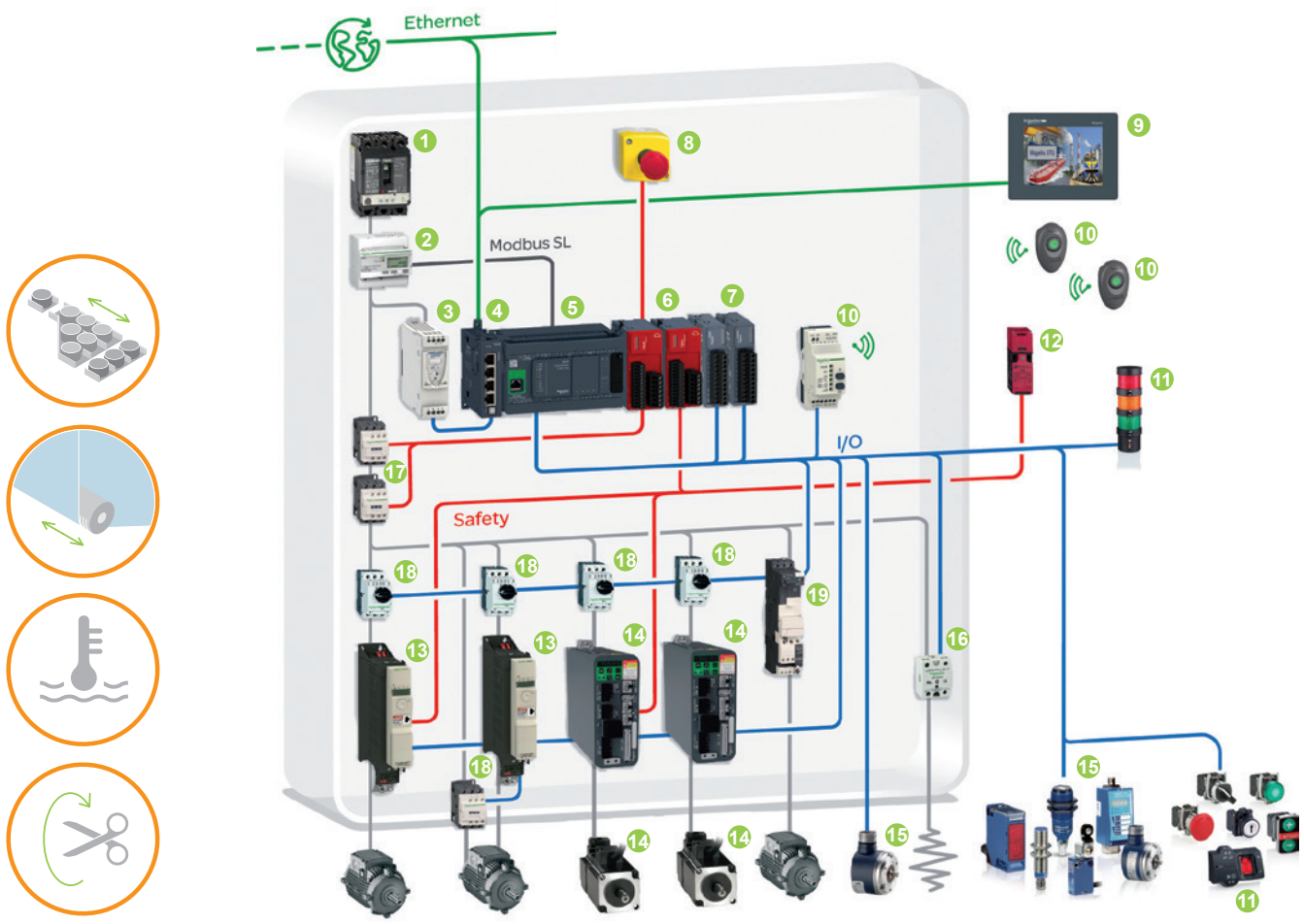

Application Function Blocks (AFB)

Compact / Hardwired / Logic Controller *Modicon M241*

- | | |
|--|---|
| Solution Breakdown | |
| 1 Compact NSX circuit breaker | 11 Harmony XB4/XB5 Control & signaling units |
| 2 IEM32 energy meter | 12 Preventa XCS safety switch |
| 3 Phaseo switch mode power supply | 13 Altivar 32 variable speed drive |
| 4 Modicon TM4 Ethernet switch module | 14 Lexium 28 Servo Drive, BCH2 servo motor |
| 5 Modicon M241 logic controller | 15 Telemecanique sensors®: proximity & photoelectric sensors, limit switch, encoder |
| 6 Modicon TM3 functional safety module | 16 Zelio Relay solid-state relay |
| 7 Modicon TM3 I/O expansion module | 17 TeSys D switch connector fuse |
| 8 Harmony XALK emergency stop | 18 TeSys GV2L magnetic circuit breaker |
| 9 Magelis STO/STU HMI | 19 TeSys GV2M/3P D.O.L. / reversing starter |
| 10 Harmony XB5R wireless and batteryless pushbutton, configurable access point | |

Lexium 28 & BCH2: optimized servo bundles for compact machines

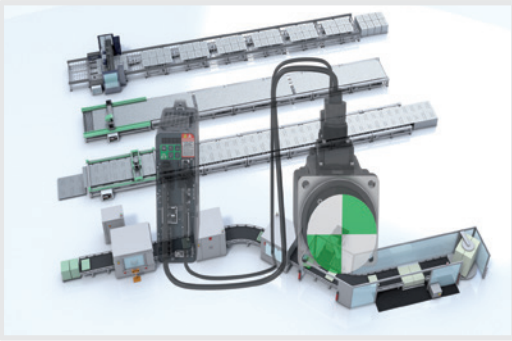

Servo range with best-in-class performance

The predefined servo bundles of Lexium 28 servo drive & BCH2 servo motor are optimized for easy integration & commissioning in your machine. It includes standard interfaces, embedded safety function and DC-bus sharing.

- > CANopen / CANmotion and EtherCAT
- > Pulse Train

Reduce your time to market

- > Automatic tuning and motor identification
- > PLC open motion library

Increase profitability

- > Designed for optimized & cost effective solutions
- > Drive embedded safety function: Safe-Torque-Off

Improve efficiency

- > Energy efficient because of DC-bus sharing
- > Predefined servo bundles to fit each machine type

Simplify integration & maintenance

- LXM28A●●● servo drives**
- > Standard fieldbus interface CANopen / CANmotion
 - > Pulse-train-input (PTI) and Pulse-train-output (PTO) interfaces
 - > Digital input interface to control simple movements directly by the servo drive: Position sequence mode
 - > Analog input interface +/-10 V for speed control mode

- LXM28E●●● servo drives**
- > Standard fieldbus interface EtherCAT
 - > Pulse-train-output (PTO) interface
 - > Digital input interface for sensor signals such as fast capture signals, limit switches and homing sensors
 - > Servo drive embedded safety function Safe-Torque-Off (STO)

Achieve benchmark performance while increasing profitability

Lexium 28 and Lexium BCH2, the optimized servo bundle for motion control solutions

- > Cost effective
- > Energy efficient
- > Embedded safety

Intuitive commissioning & programming



EcoStruxure Machine Expert configuration software



SoMove Setup software

EcoStruxure Machine Expert - One software for commissioning and programming

EcoStruxure Machine Expert is the universal programming software for machines automated by EcoStruxure Machine controllers. Simple navigation that requires only fewer clicks delivers a more efficient engineering process. The programming, visualization, and commissioning are handled in just one intuitive tool. SoMachine software includes a 21 day free trial. After this period a license is required to continue to benefit from SoMachine. It can be installed from a DVD. Please consult on our web site www.schneider-electric.com

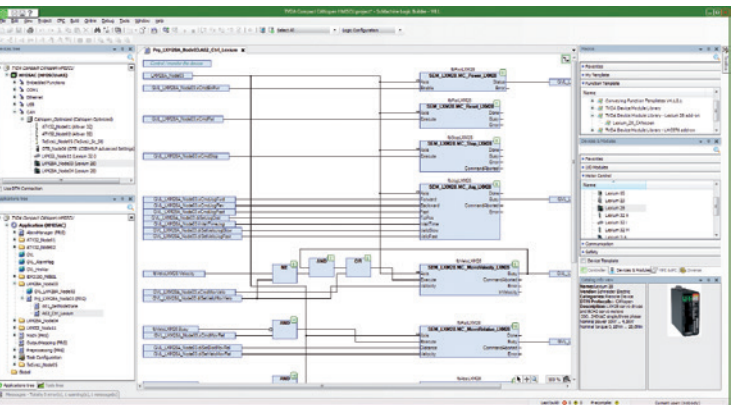

SoMove Setup software

In addition to EcoStruxure Machine Expert the SoMove Setup software can be used for the commissioning of Lexium 28. This could be done in just the same way as it is on other Schneider Electric drives and starters, to configure, adjust, debug, and maintain the drive.

Presentation

The Lexium 28 range is defined by AC-servo drives LXM28 for combination with AC-servo motors BCH2.

- The Lexium 28 range offers predetermined combinations to suit the requirements of motion control applications, and optimize installation's performance.
- The combinations of servo motors with servo drives are based on the power class: both servo motor and servo drive have the same power class.
- The bundle of a servo drive with its related servo motor is designed to cover a nominal power from 0.05 kW up to 4.5 kW (0.067 up to 6.03 hp) with 200..240 V mains supply voltage.
- The Lexium 28 servo drives are delivered without EMC filter, the EMC immunity is reached with additional EMC filter.
- The Lexium 28 servo drives have degree of protection IP 20.
- BCH2 motors provide a nominal torque from 0.16 Nm to 28.6 Nm and a nominal speed of from 1,500 to 3,000 rpm, depending on the model. They are suitable for a wide variety of applications due to the different levels of motor inertia offered.

Compact range

The compact dimensions of Lexium 28 servo drives mean they fit very easily into small spaces, thus reducing the size of the installation and the cost of the equipment.

Applications

- Material working (multi-axis machines, cutting machines, etc.)
- Material handling (conveying, palletizers, warehousing, etc.)
- Assembly line (clamping, etc.)
- Packaging
- Printing
- Winding and unwinding

SoMove Setup software

SoMove Setup software is used for commissioning, parameter setting, diagnostics and maintenance.

The drives can be configured

- via their integrated HMI interface
- using the SoMove Setup software.

It can also be used for fast device replacement in existing machine installations.

SoMove Setup software is used in just the same way as it is on other Schneider Electric drives, for configuring and optimizing control loops in automatic or manual mode using the Oscilloscope function and for maintenance of the Lexium 28 drive. See page 10.

Multi-loader tool

The Multi-loader tool enables configurations to be copied from a PC or a servo drive and loaded onto another servo drive. The servo drives do not need to be powered-up (see page 10).

Flexibility

- LXM28A●●● servo drives have digital and analog I/O as standard, an interface for CANopen/CANmotion fieldbus and an encoder interface for BCH2 servo motors.
- LXM28E●●● are controlled through the field bus interface EtherCAT.

The servo drives incorporate numerous functions, including auto-tuning, position, speed, torque control.

LXM28A●●● drives can be used with drive embedded "position sequence mode", controlled through digital input signals.

This open communication concept enables integration into numerous different control system architectures.

Mounting and maintenance

Connecting the servo drives is simplified by identified plug-in connectors, which are easily accessed, mainly on the front panel and also on top of the drive (see Description page 9).



Material working application



Material handling application



Packaging application



Textile application



SoMove Setup software



Multi-loader tool

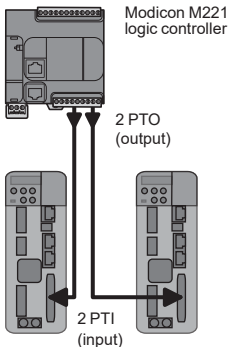

Example of architecture with two LXM28A servo drives controlled by Modicon M221 logic controller

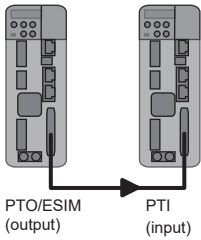

Example of a LXM28A servo drive via PTO/ESIM interface, controlling another LXM28A servo drive with PTI interface

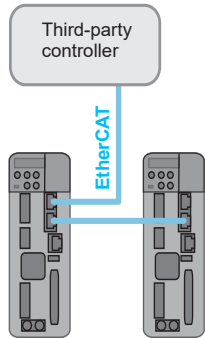

Example of EtherCAT architecture with two LXM28E servo drives controlled by a third-party controller

PTO: pulse-train-output
 ESIM: encoder simulation output. The servo drive provides its motor position through this electrical interface to another device.
 PTI: pulse-train-input interface



Guard monitoring safety function held by Lexium 28 servo drives. More details on our web site [Machine Safety Solution](#)

Main functions of Lexium 28 servo drives

- Automatic motor identification by the servo drive: the technical data related to the motor is provided from the motor to the drive via the encoder connection cable.
- Filtering: Anti-vibration function for suppression of resonance frequencies of the power train connected with the moving mass of the application
- Monitoring functions:
 - Status monitoring, I/O monitoring
 - Log function to memorize alarm and warning messages (in the drive)
 - Reset function of alarms and warnings
 - Monitoring of drive variables related to motor control and closed loop control
- **Additional main function:** Movement control with digital input interface directly in the servo drive:
 - Relative or absolute positioning mode
 - Velocity mode
 - Torque control mode
 - Position sequence mode: a sequence of up to 32 movements, controlled by a digital input interface

Control via I/O interface or fieldbus

LXM28A servo drives are controlled through “CN4 CAN” interface with a CANopen/CANmotion fieldbus control interface. They can also be controlled through numerous digital and analog signals, accessible by “CN1 I/O” interface:

- 2 digital inputs for high performance position capture
- 8 digital inputs
- 5 digital outputs
- 2 analog inputs
- 2 analog outputs
- 1 digital input channel (2 wires) for the safety function “Safe-Torque-Off”

LXM28E servo drives are controlled through “CN4 Eth” interface with an EtherCAT fieldbus control interface. They can also be controlled through numerous digital and analog signals, accessible by “CN1 I/O” interface:

- 2 digital inputs for high performance position capture
- 8 digital inputs
- 5 digital outputs
- 1 digital input channel (2 wires) for the safety function “Safe-Torque-Off”

Drive functions activated by commissioning software or directly by the HMI interface

- Jog mode: Velocity movement
- “Easy tuning” one-button tuning mode: this function is used to optimize application performance.
- 2 additional tuning functions, which can be activated by the SoMove Setup commissioning software or by the HMI interface:
 - “Comfort tuning” with predefined settings for different mechanical systems such as spindle axes (e.g. portal axes), transportation belt, vertical axes (e.g. cantilever axes)
 - “Auto-adaptive tuning”

Operating modes

Operating modes for LXM28A servo drives via PTI/PTO interface

- Lexium 28 drives movement can be managed by a machine controller (Modicon M221 logic controller) with pulse-train-output (PTO) interface or the PTO interface from another (Lexium28) servo drive.
- The corresponding pulse-train-input (PTI) of the LXM28A drive is then electrically connected to CN1 I/O interface.

Operating modes for LXM28A or LXM28E servo drives via the CANopen and CANmotion fieldbus and for LXM28E servo drives via EtherCAT field bus

- Homing
- Point-to-point mode
- Position gear mode
- Cyclic synchronous position mode, cyclic synchronous velocity mode, cyclic synchronous torque mode

For more details of each integrated function, please consult our web site: www.schneider-electric.com.

Embedded safety function STO

The Lexium 28 range of servo drives is an integral part of the Machine safety system “Preventa solutions for efficient machine safety” with its drive embedded Safe-Torque-Off (STO) function. This STO function meets the requirements of SIL 2 according IEC 61800-5-2 / IEC62061 / IEC 61508 as well as up to category 3 and PL d according to EN ISO 13849-1. It simplifies the setup of installations requiring complex safety equipment and improves performance during maintenance operations.

Lexium 28 & Motors

Lexium 28 servo drives and BCH2 servo motors



LXM28A●●●
(0.05...0.75 kW)

LXM28E●●●



Lexium 28A●●●
(1 and 1.5 kW)

Lexium 28E●●●



LXM28A●●●
(2 kW)

Lexium 28E●●●



Lexium 28A●●●
(3 and 4.5 kW)

Lexium 28E●●●

BCH2 servo motors and Lexium 28 servo drives combinations

Servo drive	Available power output		Nominal speed of rotation rpm	Nominal torque		Maximum peak torque		Servo motor	Inertia (without holding brake) kgcm ²	Motor inertia type
	kW	hp		Nm	ft lbf	Nm	ft lbf			
Single-phase supply voltage: 200/240 VAC										
LXM28AU05M3X LXM28EU05M3X	0.05	0.067	3,000	0.16	0.11	0.48	0.35	BCH2MBA53●●●5C	0.054	Medium
LXM28AU01M3X LXM28EU01M3X	0.1	0.13	3,000	0.32	0.23	0.96	0.70	BCH2MB013●●●5C	0.075	Medium
LXM28AU02M3X LXM28EU02M3X	0.2	0.26	3,000	0.64	0.47	1.92	1.41	BCH2LD023●●●5C	0.16	Low
LXM28AU04M3X LXM28EU04M3X	0.3	0.41	1,000	2.86	2.10	8.59	6.33	BCH2MM031●●●6C	6.63	Medium
	0.4	0.53	3,000	1.27	0.93	3.81	2.81	BCH2LD043●●●5C	0.27	Low
	0.4	0.53	3,000	1.27	0.93	3.81	2.81	BCH2LF043●●●5C	0.67	Low
LXM28AU07M3X LXM28EU07M3X	0.5	0.67	2,000	2.39	1.76	7.16	5.28	BCH2MM052●●●6C	6.63	Medium
	0.6	0.80	1,000	5.73	4.22	17.19	12.67	BCH2MM061●●●6C	6.63	Medium
	0.75	1.00	3,000	2.39	1.76	7.16	5.28	BCH2HF073●●●5C	1.54	High
	0.75	1.00	3,000	2.39	1.76	7.16	5.28	BCH2LF073●●●5C	1.19	Low
LXM28AU10M3X LXM28EU10M3X	0.85	1.13	1,500	5.39	3.97	13.8	10.17	BCH2MM081●●●6C	13.5	Medium
	0.9	1.21	1,000	8.59	6.33	25.77	19.01	BCH2MM091●●●6C	9.7	Medium
	1	1.34	3,000	3.18	2.34	9.54	7.03	BCH2LH103●●●6C	2.4	Low
	1	1.34	2,000	4.77	3.51	14.3	10.54	BCH2MM102●●●6C	6.63	Medium
	1	1.34	2,000	4.77	3.51	14.3	10.54	BCH2HM102●●●6C	8.53	High
LXM28AU15M3X LXM28EU15M3X	1.5	2.01	2,000	7.16	5.28	21.48	15.84	BCH2MM152●●●6C	9.7	Medium
3 phase supply voltage: 200/240 VAC										
LXM28AU05M3X LXM28EU05M3X	0.05	0.067	3,000	0.16	0.11	0.48	0.35	BCH2MBA53●●●5C	0.054	Medium
LXM28AU01M3X LXM28EU01M3X	0.1	0.13	3,000	0.32	0.23	0.96	0.70	BCH2MB013●●●5C	0.075	Medium
LXM28AU02M3X LXM28EU02M3X	0.2	0.26	3,000	0.64	0.47	1.92	1.41	BCH2LD023●●●5C	0.16	Low
LXM28AU04M3X LXM28EU04M3X	0.3	0.41	1,000	2.86	2.10	8.59	6.33	BCH2MM031●●●6C	6.63	Medium
	0.4	0.53	3,000	1.27	0.93	3.81	2.81	BCH2LD043●●●5C	0.27	Low
	0.4	0.53	3,000	1.27	0.93	3.81	2.81	BCH2LF043●●●5C	0.67	Low
LXM28AU07M3X LXM28EU07M3X	0.5	0.67	2,000	2.39	1.76	7.16	5.28	BCH2MM052●●●6C	6.63	Medium
	0.6	0.80	1,000	5.73	4.22	17.19	12.67	BCH2MM061●●●6C	6.63	Medium
	0.75	1.00	3,000	2.39	1.76	7.16	5.28	BCH2HF073●●●5C	1.54	High
	0.75	1.00	3,000	2.39	1.76	7.16	5.28	BCH2LF073●●●5C	1.19	Low
LXM28AU10M3X LXM28EU10M3X	0.85	1.13	1,500	5.39	3.97	13.8	10.17	BCH2MM081●●●6C	13.5	Medium
	0.9	1.21	1,000	8.59	6.33	25.77	19.01	BCH2MM091●●●6C	9.7	Medium
	1	1.34	3,000	3.18	2.34	9.54	7.03	BCH2LH103●●●6C	2.4	Low
	1	1.34	2,000	4.77	3.51	14.3	10.54	BCH2MM102●●●6C	6.63	Medium
LXM28AU15M3X LXM28EU15M3X	1.5	2.01	2,000	7.16	5.28	21.48	15.84	BCH2MM152●●●6C	9.7	Medium
LXM28AU20M3X LXM28EU20M3X	2.0	2.68	3,000	6.37	4.69	19.1	14.08	BCH2LH203●●●6C	4.28	Low
	2.0	2.68	2,000	9.55	7.04	28.65	21.13	BCH2MM202●●●6C	13.5	Medium
	2.0	2.68	2,000	9.55	7.04	28.65	21.13	BCH2MR202●●●6C	26.5	Medium
	2.0	2.68	2,000	9.55	7.04	28.65	21.13	BCH2HR202●●●6C	34.67	High
LXM28AU30M3X LXM28EU30M3X	3.0	4.02	1,500	19.1	14.08	57.29	42.25	BCH2MR301●●●6C	53.56	Medium
	3.0	4.02	2,000	14.32	10.56	42.97	31.69	BCH2MR302●●●6C	53.56	Medium
LXM28AU45M3X LXM28EU45M3X	3.5	4.69	2,000	16.7	12.31	50.3	37.09	BCH2MR352●●●6C	53.56	Medium
	4.5	6.03	1,500	28.65	21.13	71.62	52.82	BCH2MR451●●●6C	73.32	Medium

Lexium 28 & Motors

Lexium 28 servo drives

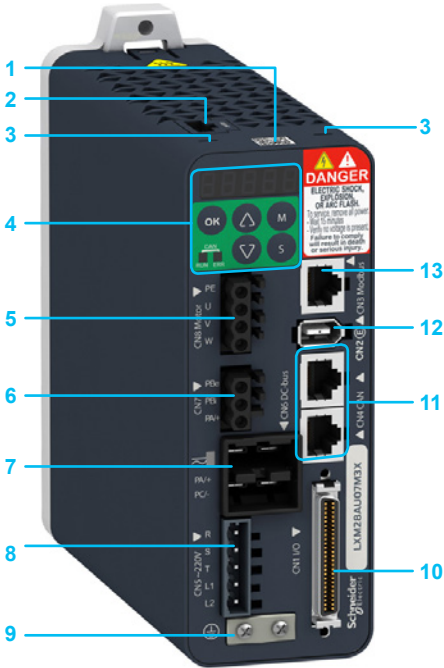

LXM28A●●●

LXM28A servo drives

Description

On the drive top side:

- 1 QR code for access to detailed technical data, wiring guide, and installation guide
- 2 Removable terminal (1) for STO function (marked "CN9")
- 3 Slot for application name plate

On the drive front side:

- 4 HMI interface, 7-segment display, 5 buttons (OK, mode, set, value up, value down) and servo drive status LED
- 5 Removable terminal block (1) for motor connection (marked "CN8 Motor")
- 6 Removable terminal block (1) for braking resistor connection (marked "CN7")
- 7 DC-bus connector with status LED "DC-bus charged" (marked "CN6 DC-bus")
- 8 Removable terminal block (1), 5 terminals (R, S, T, L1, L2) for connecting the 220 V ~ power supply (marked "CN5 ~ 220 V")
- 9 Protected earth connector (marked "⊕")
- 10 Input/output interface connector (marked "CN1 I/O")
- 11 2x RJ 45 connectors for CANopen/CANmotion fieldbus connection (marked "CN4 CAN")
- 12 Connector for motor encoder: 20-bit single-turn or multi turn absolute encoder, type ServoSense® (marked "CN2 ⓔ")
- 13 RJ 45 connector for Modbus serial link (marked "CN3 Modbus")

(1) Removable spring terminals are supplied with each Lexium 28 servo drive.

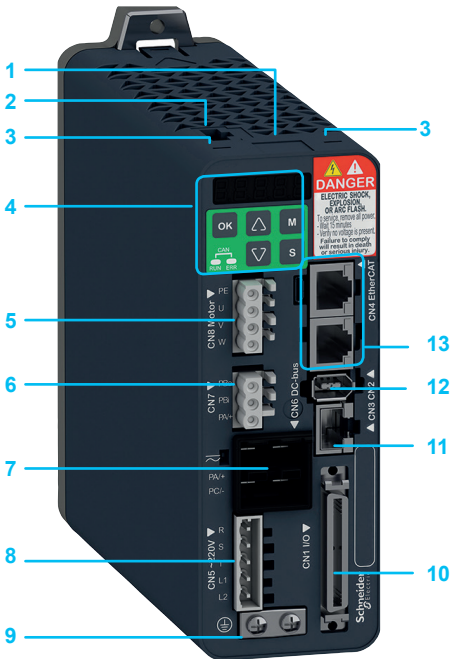

LXM28E●●●

LXM28E servo drives

Description

On the drive top side:

- 1 QR code for access to detailed technical data, wiring guide, and installation guide
- 2 Removable terminal (1) for STO function (marked "CN9")
- 3 Slot for application name plate

On the drive front side:

- 4 HMI interface, 7-segment display, 5 buttons (OK, mode, set, value up, value down) and servo drive status LED
- 5 Removable terminal block (1) for motor connection (marked "CN8 Motor")
- 6 Removable terminal block (1) for braking resistor connection (marked "CN7")
- 7 DC-bus connector with status LED "DC-bus charged" (marked "CN6 DC-bus")
- 8 Removable terminal block (1), 5 terminals (R, S, T, L1, L2) for connecting the 220 V ~ power supply (marked "CN5 ~ 220 V")
- 9 Protected earth connector (marked "⊕")
- 10 Input/output interface connector (marked "CN1 I/O")
- 11 RJ 45 connector for Modbus serial link (marked "CN3 Modbus")
- 12 Connector for motor encoder: 20-bit single-turn or multi turn absolute encoder, type ServoSense® (marked "CN2 ⓔ")
- 13 2x RJ 45 connectors for EtherCAT fieldbus connection (marked "CN4 ETHERcat")

(1) Removable spring terminal blocks are supplied with each Lexium 28 servo drive.

Lexium 28 servo drives										
References										
To order a Lexium 28 servo drive, make up the reference as follows:										
Example										
Lexium 28 AC servo drive	L	X	M	2	8	A	U	A	5	M 3 X
Interface	CANopen and CANmotion fieldbus					A				
	EtherCAT fieldbus					E				
Power	50 W (0.067 hp)						U	A	5	
	100 W (0.13 hp)						U	0	1	
	200 W (0.26 hp)						U	0	2	
	400 W (0.53 hp)						U	0	4	
	750 W (1.00 hp)						U	0	7	
	1 kW (1.34 hp)						U	1	0	
	1.5 kW (2.01 hp)						U	1	5	
	2 kW (2.68 hp)						U	2	0	
	3 kW (4.02 hp)						U	3	0	
	4.5 kW (6.03 hp)						U	4	5	
Supply voltage	200...240 VAC, no EMC filter								M	3 X

Dimensions and weight				
Servo drive reference	Housing size	Dimensions (overall)		Weight kg/ lb
		Width x Height x Depth (W x H x D)		
		mm	in.	
Single-phase or 3 phase supply voltage: 200/240 VAC				
LXM28AU01M3X LXM28EUA5M3X LXM28AU01M3X LXM28EU01M3X LXM28AU02M3X LXM28EU02M3X LXM28AU04M3X LXM28EU04M3X LXM28AU07M3X LXM28EU07M3X	Size 1	55 x 150 x 146	2.17 x 5.91 x 5.75	1.000 / 2.190
LXM28AU10M3X LXM28EU10M3X LXM28AU15M3X LXM28EU15M3X	Size 2	55 x 150 x 170	2.17 x 5.91 x 6.69	1.200 / 2.630
LXM28AU20M3X LXM28EU20M3X	Size 3	62 x 170 x 184	2.44 x 6.69 x 7.24	1.700 / 3.720
LXM28AU30M3X LXM28EU30M3X LXM28AU45M3X LXM28EU45M3X	Size 4	116 x 234 x 186	4.56 x 9.21 x 7.32	3.200 / 7.010

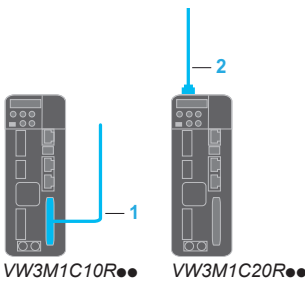
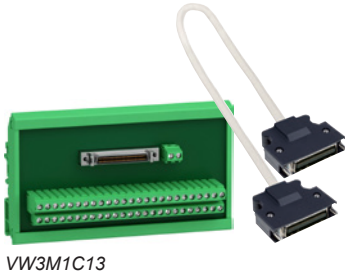

Servo drive with application name plate VW3M2501

Connection accessories

Cordsets

Designation	Use	Description	Length m/ft	Unit reference	Weight kg/lb
Daisy chain connection of the DC-bus (sold in lots of 5)	Between LXM28A and LXM28A drives, Between LXM28E and LXM28E drives	Equipped with 2 connectors	0.1 / 0.33	VW3M7101R01	0.150/ 0.220

Cable

Designation	Use	Description	Length m/ft	Reference	Weight kg/lb
Shielded cable for Daisy chain connection of the DC-bus	Between LXM28A and LXM28A drives, or etween LXM28E and LXM28E drives	This cable can be used with DC-bus connector kit VW3M2207	15 / 49.21	VW3M7102R150	3.650/ 8.047

Connectors

Designation	Use	Description	Unit reference	Weight kg/lb
DC-bus connector kit	LXM28A, LXM28E	10 connectors for creating extension cordsets for the CN6 DC-bus interface	VW3M2207	0.050/ 0.110
Replacement connector sets	For 50 W to 1.5 kW (0.067 hp to 2.01 hp) drives	3 connectors: 1 for CN5, 1 for CN7, and 1 for CN8 interfaces	VW3M4C21 (sold in lots of 3)	0.100/ 0.220
	For 2 kW (2.68 hp) drives	3 connectors: 1 for CN5, 1 for CN7, and 1 for CN8 interfaces	VW3M4C23 (sold in lots of 2)	0.120/ 0.264
	For 3 kW and 4.5 kW (4.02 hp and 6.03 hp) drives	3 connectors: 1 for CN5, 1 for CN7, and 1 for CN8 interfaces	VW3M4C24 (sold in lots of 2)	0.120/ 0.264

I/O connector	LXM28A, LXM28E	SUB-D 50-pin connector for CN1 I/O interface	VW3M1C12 (sold in lots of 3)	0.100/ 0.220
I/O terminal block module	LXM28A, LXM28E	Terminal block + Cordset Composed with 2x SUB-D 50-pin connectors type VW3M1C12, and one 0.5 m / 1.640 ft. cable, for CN1 I/O interface connection	VW3M1C13	0.380/ 0.838

Cordsets

Designation	Use	Description	Length m/ft	Reference	Weight kg/lb
I/O PTI connection cordsets	LXM28A, LXM28E	Equipped with one SUB-D 50-pin connector for connection on CN1 interface (drive side), and open end (controller side)	1 / 3.28	VW3M1C10R10	0.100/ 0.220
			2 / 6.56	VW3M1C10R20	0.200/ 0.441
			3 / 9.84	VW3M1C10R30	0.300/ 0.661
STO connection cordsets	LXM28A, LXM28E	Equipped with one Molex 4-pin connector for connection on CN9 interface (drive side), and open end (controller side)	1 / 3.28	VW3M1C20R10	0.100/ 0.220
			2 / 6.56	VW3M1C20R20	0.200/ 0.441
			3 / 9.84	VW3M1C20R30	0.300/ 0.661

Accessory

Designation	Use	Description	W x H mm/in.	Unit reference	Weight kg/lb
Application name plate	To be inserted onto a dedicated slot on the top of the servo drive	It contains information about the servo drive	38.5 x 13 / 1.516 x 0.512	VW3M2501 (sold in lots of 50)	0.100/ 0.220



Configuration with the SoMove Setup software



TCSMCNAM3M002P

SoMove Setup software

Presentation

SoMove Setup software is used on Lexium 28 servo drives in just the same way as it is on other Schneider Electric drives and starters, to configure, adjust, debug, and maintain the drive.

The configuration of Lexium 28 servo drives can be done using the USB/RJ 45 cordset TCSMCNAM3M002P (used between the PC and the Lexium 28, on CN3 interface).

SoMove Setup software can be downloaded from our web site: www.schneider-electric.com

More information: see catalog "SoMove Setup software" (DIA2ED2140801EN) on our web site: www.schneider-electric.com

References

Designation	Description	Reference	Weight kg/lb
USB/RJ 45 cordset	<ul style="list-style-type: none"> ■ For connecting a PC to the device (Lexium 28) ■ Length: 2.5 m (8.2 ft.) ■ Equipped with a USB connector (PC end), and an RJ 45 connector (Device end) 	TCSMCNAM3M002P	0.160 / 0,353

Multi-loader configuration tool

Presentation

The Multi-loader tool enables several configurations to be copied from a PC or a Lexium 28 servo drive and loaded onto another servo drive.

The Lexium 28 servo drives do not need to be powered up.



Configuration of a Lexium 28 in its packaging with the VW3A8121 Multi-loader tool + VW3A8126 cordset



VW3A8126

References

Designation	Description	Reference	Weight kg/lb
Multi-loader configuration tool	Supplied with: <ul style="list-style-type: none"> □ 1 cordset equipped with two RJ 45 connectors □ 1 cordset equipped with one type A USB connector and one mini B USB connector □ 1 x 2 GB SD memory card □ 1 x female/female RJ 45 adapter □ 4 AA 1.5 V LR6 round batteries 	VW3A8121	0.910/ 2.006
Cordset for multi-loader tool	For connecting the multi-loader tool to the Lexium 28 servo drive in its packaging. Equipped with: <ul style="list-style-type: none"> □ A non-locking RJ 45 connector with special mechanical catch on the drive end □ An RJ 45 connector on the Multi-loader end 	VW3A8126	0.065 / 0.143

Options: braking resistors for servo drives

Presentation

Internal braking resistor

A braking resistor is built into the servo drive to absorb the braking energy. If the DC-bus voltage in the servo drive exceeds a specified value, this braking resistor is activated. The restored energy is converted into heat by the braking resistor. It enables maximum transient braking torque.

External braking resistor

When the servo motor has to be braked frequently, an external braking resistor is required to dissipate the excess braking energy. In this case, the internal braking resistor must be deactivated.

Several external braking resistors can be connected in parallel. The servo drive monitors the power dissipated in the braking resistor.

The casing degree of protection is IP 65 for VW3A7601R●● to VW3A7607R●● braking resistors and IP 20 for VW3A770● braking resistors.

The operating temperature around the unit can be between 0 and + 50 °C (+ 32 and + 122 °F).

To optimize the size of the braking resistor, the DC-buses on Lexium 28 servo drives in the same installation can be connected in parallel.

Applications:

Machines with high inertia, driving loads, and machines with fast cycles.

References

External braking resistor

Ohmic value Ω	Continuous power		Peak energy 230 V Ws	Length of connection cable		Reference	Weight kg/lb
	W	hp		m	ft		
10	1,000	1.34	36,500	–	–	VW3A7705	11.000/ 24.251
15	1,000	1.34	43,100	–	–	VW3A7704	11.000/ 24.251
27	100	0.13	3,800	0.75	2.46	VW3A7602R07	0.630/ 1.389
					2	6.56	VW3A7602R20
				3	9.84	VW3A7602R30	0.900/ 1.984
	200	0.26	7,400	0.75	2.46	VW3A7603R07	0.930/ 2.050
					2	6.56	VW3A7603R20
				3	9.84	VW3A7603R30	1.200/ 2.646
400	0.53	18,100	0.75	2.46	VW3A7604R07	1.420/ 3.131	
				2	6.56	VW3A7604R20	1.470/ 3.241
			3	9.84	VW3A7604R30	1.620/ 3.571	
	200	0.26	9,600	0.75	2.46	VW3A7606R07	0.930/ 2.050
					2	6.56	VW3A7606R20
				3	9.84	VW3A7606R30	1.200/ 2.646
400	0.53	24,700	0.75	2.46	VW3A7607R07	1.420/ 3.131	
				2	6.56	VW3A7607R20	1.470/ 3.241
			3	9.84	VW3A7607R30	1.620/ 3.571	

Note: The total continuous power dissipated in the external braking resistor(s) must be less than or equal to the nominal power of the Lexium 28 servo drive.



VW3A760●R●●



VW3A770●

Lexium 28 & Motors

Lexium 28 servo drives

Communication on CANopen/CANmotion fieldbus with LXM28A●●● servo drives

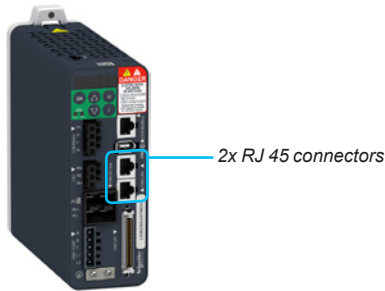

LXM28A●●●

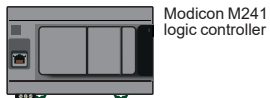

Modicon M241 logic controller

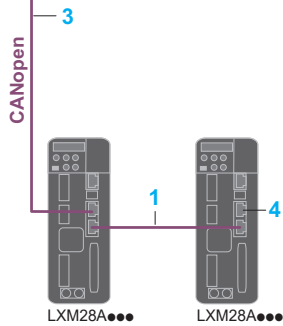

Modicon LMC058 motion controller

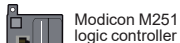
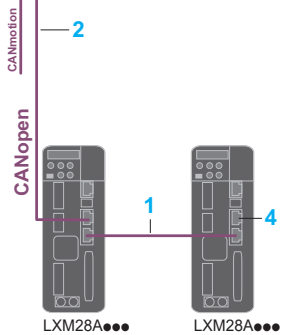

Modicon M251 logic controller

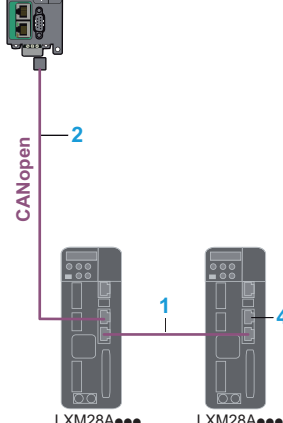

Examples of architectures with control by Modicon M241/M251 logic controllers or LMC058 motion controller

CANopen/CANmotion fieldbus for LXM28A●●● servo drives

Presentation

LXM28A●●● servo drives integrate the CANopen communication protocol as standard.

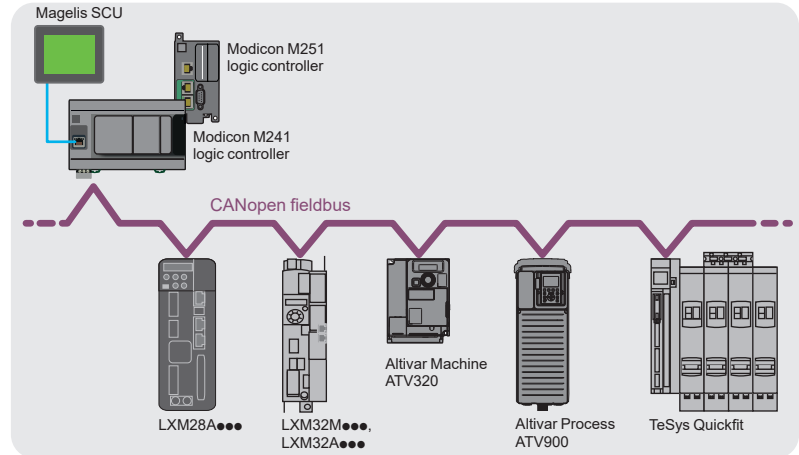

LXM28A●●● servo drives can be directly connected to CANopen/CANmotion fieldbus using the RJ 45 connectors. The communication function provides access to the servo drive's configuration, adjustment, control, and monitoring functions. To simplify daisy chain connection, each servo drive is equipped with two RJ 45 connectors (marked CN4 CAN).

Cordsets and cables (1)

Description	Item no.	Length m (ft)	Reference	Weight kg/lb
CANopen cordsets (1) Equipped with 2 RJ 45 connectors	1	0.3 (0.98)	VW3CANCARR03	0.320/ 0.705
		1 (3.28)	VW3CANCARR1	0.500/ 1.102
CANopen cordsets (1) Equipped with one 9-way female SUB-D connector with integrated line terminator and one RJ 45 connector	2	1 (3.28)	VW3M3805R010	0.080/ 0.176
		3 (9.843)	VW3M3805R030	0.139/ 0.306
CANopen cables (1) Standard cables, CE marking, Low smoke, zero halogen, Flame retardant (IEC 60332-1)	3	50 (164.04)	TSXCANCA50	4.930/ 10.869
		100 (328.08)	TSXCANCA100	8.800/ 19.401
		300 (984.25)	TSXCANCA300	24.560/ 54.145
CANopen cables (1) UL certification, CE marking, Flame retardant (IEC 60332-2)	3	50 (164.04)	TSXCANCB50	3.580/ 7.893
		100 (328.08)	TSXCANCB100	7.840/ 17.284
		300 (984.25)	TSXCANCB300	21.870/ 48.215
CANopen cables (1) Cables for harsh environments (2) or mobile installation, CE marking, Low smoke, zero halogen, Flame retardant (IEC 60332-1)	3	50 (164.04)	TSXCANCD50	3.510/ 7.738
		100 (328.08)	TSXCANCD100	7.770/ 17.130
		300 (984.25)	TSXCANCD300	21.700/ 47.840

Connection accessories (1)

Description	Item no.	Use	Reference	Weight kg/lb
CANopen line terminator for RJ 45 connector 120 Ω	4	Lexium28	TCSCAR013M120	0.009/ 0.020

(1) For other CANopen fieldbus connection accessories, please consult our web site: www.schneider-electric.com

(2) Harsh environment:

- Resistance to hydrocarbons, industrial oils, detergents, solder splashes
- Relative humidity up to 100%
- Saline atmosphere
- Significant temperature variations
- Operating temperature between - 10 °C/+ 14 °F and + 70 °C/+ 158 °F

Lexium 28 & Motors

Lexium 28 servo drives

Communication on EtherCAT fieldbus with LXM28E●●● servo drives



2x RJ 45 connectors,
for EtherCAT fieldbus connection

LXM28E●●●

EtherCAT fieldbus for LXM28E●●● servo drives

Presentation

EtherCAT (EtherNet for Control Automation Technology) is an EtherNet-based open fieldbus system. This means that EtherNet technologies, such as embedded Web server, e-mail, and FTP transfer, can be used in the EtherCAT environment. The EtherCAT fieldbus is intended for applications requiring very short cycle times ($\leq 250 \mu s$) with low jitter ($\leq 1 \mu s$) for synchronization purposes

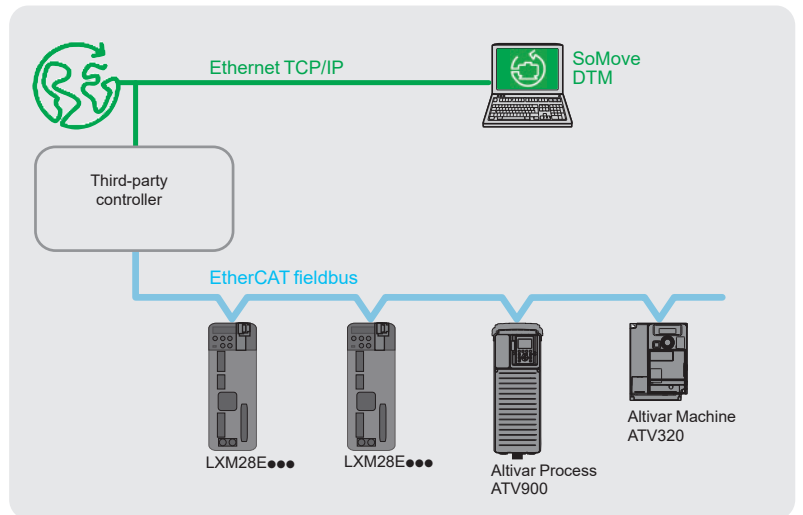

LXM28E●●● servo drives can be directly connected to EtherCAT fieldbus using the RJ 45 connectors. The communication function provides access to the servo drive's configuration, adjustment, control, and monitoring functions..

Cordsets

Description	Length m (ft) (1)	Reference	Weight kg/lb
ConneXium cordsets: conforming to EIA/TIA-568, category 5, and IEC1180/EN50173, class D, standards			
Straight shielded twisted pair cordsets Equipped with 2 RJ 45 connectors	2 (6.56)	490NTW00002	–
	5 (16.40)	490NTW00005	–
	12 (39.37)	490NTW00012	–
Crossed shielded twisted pair cordsets Equipped with 2 RJ 45 connectors	5 (16.40)	490NTC00005	–
	15 (49.21)	490NTC00015	–
ConneXium cordsets: conforming to UL and CSA 22.1 standards			
Straight shielded twisted pair cordsets Equipped with 2 RJ 45 connectors	2 (6.56)	490NTW00002U	–
	5 (16.40)	490NTW00005U	–
	15 (49.21)	490NTW00012U	–
Crossed shielded twisted pair cordsets Equipped with 2 RJ 45 connectors	5 (16.40)	490NTC00005U	–

(1) Also available in 40 and 80 m/131 and 262 ft lengths. To order other ConneXium connection components, please refer to our website www.schneider-electric.com.

Lexium 28 & Motors

Lexium 28 servo drives

Additional EMC input filters

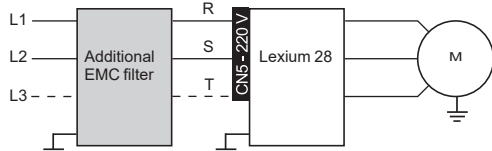

Lexium 28 servo drive with additional EMC filter



VW3A4420 EMC filter and Lexium 28 servo drive



VW3A4422

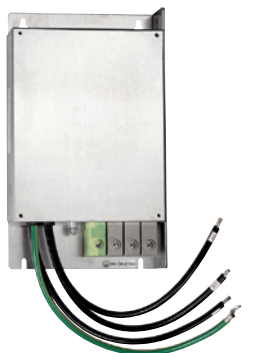

VW3A4424

Additional EMC input filters for servo drives

Presentation

Lexium 28 servo drives require external input filters to comply with the EMC standard for variable speed electrical power drive "products" IEC/EN 61800-3, edition 2, category C3 in environment 2, and to comply with the European directive on EMC (electromagnetic compatibility).

Applications

Additional EMC filters are mounted next to the device. They have tapped holes for mounting in an enclosure.

The maximum servo motor cable length conforming to IEC/EN 61800-3 category C3 (1) in environment 2 is 20 m (65.62 ft).

Use according to the type of line supply

Integrated or additional EMC filters can only be used on TN (neutral connection) or TT (neutral to ground) systems.

Lexium 28 servo drives cannot be used on IT (impedance grounded or isolated neutral) systems. Standard IEC/EN 61800-3, appendix D2.1, states that on IT systems, filters can cause permanent insulation monitors to operate in a random manner.

If a machine has to be installed on an IT system, an isolation transformer must be inserted in order to re-create a TT system on the secondary side.

References

Designation	Max. nominal power Combination	Line current (A)	Reference	Weight kg/lb
Single-phase supply voltage				
Additional EMC input filters for Lexium 28 servo drives	50 W to 750 W (0.067 to 1.00 hp) servo drives 1x EMC filter and a single Lexium 28 servo drive	9	VW3A4420	0.600/ 1.323
	1 kW and 1.5 kW (1.34 hp and 2.01 hp) servo drives 1x EMC filter and a single Lexium 28 servo drive	16	VW3A4421	0.775/ 1.709
	7.5 kW max (10.05 hp max) servo drives 1x common EMC filter and several Lexium 28 servo drives	24	VW3A4426	1.130/ 2.491
Three-phase supply voltage				
Additional EMC input filters for Lexium 28 servo drives	50 W to 1.5 kW (0.067 hp to 2.01 hp), 2kW (2.68 hp), and 3kW (4.02 hp) servo drives 1x EMC filter and a single Lexium 28 servo drive	15	VW3A4422	0.900/ 1.984
	4.5 kW (6.03 hp) servo drives 1x EMC filter and a single Lexium 28 servo drive	25	VW3A4423	1.350/ 2.976
	Up to 10 kW (up to 13.40 hp) servo drives 1x common EMC filter and several Lexium 28 servo drives	47	VW3A4424	3.150/ 6.945

(1) Standard IEC/EN 61800-3: EMC immunity and conducted and radiated EMC emissions:
- Category C3 in environment 2: industrial premises.



GV2P●●



LC1●●●



LXM28

Motor starters

Presentation

The combinations listed below can be used to create a complete motor starter unit comprising a circuit breaker, a contactor, and a Lexium 28 servo drive.

- GV2P circuit-breaker provides protection against accidental short-circuits, disconnection and, if necessary, isolation.
- LC1 contactor turns on and manages any safety functions, as well as isolating the servo motor on stopping.
- Lexium 28 servo drive controls the servo motor, provides protection against short-circuits between the servo drive and the servo motor, and protects the motor cable against overloads. Overload protection is provided by the servo drive's motor thermal protection.

Combinations

Servo drive Reference	Nominal power		Mains number of phases	Circuit-breaker (1)		Contactor
	kW	hp		Reference	Rating A	Reference (2) (3)
Mains supply voltage: 200...240 VAC 50/60Hz						
LXM28AUA5M3X, LXM28EUA5M3X	0.05	0.067	1 or 3 phases	GV2P14	10	LC1K0610●●
LXM28AU01M3X, LXM28EU01M3X	0.1	0.13	1 or 3 phases	GV2P14	10	LC1K0610●●
LXM28AU02M3X, LXM28EU02M3X	0.2	0.26	1 or 3 phases	GV2P14	10	LC1K0610●●
LXM28AU04M3X, LXM28EU04M3X	0.4	0.53	1 or 3 phases	GV2P14	10	LC1K09●●
LXM28AU07M3X, LXM28EU07M3X	0.75	1.00	1 or 3 phases	GV2P14	10	LC1K09●●
LXM28AU10M3X, LXM28EU10M3X	1	1.34	1 or 3 phases	GV2P14	10	LC1K12●●
LXM28AU15M3X, LXM28EU15M3X	1.5	2.01	1 or 3 phases	GV2P16	14	LC1D18●●
LXM28AU20M3X, LXM28EU20M3X	2	2.68	3 phases	GV2P20	18	LC1D32●●
LXM28AU30M3X, LXM28EU30M3X	3	4.02	3 phases	GV2P20	18	LC1D32●●
LXM28AU45M3X, LXM28EU45M3X	4.5	6.03	3 phases	GV2P21	23	LC1D65●●

(1) Circuit-breakers for single drive installation according to IEC 60364-5-52

(2) Composition of the contactors:

LC1 K06: 3 poles + 1 N/O auxiliary contact

LC1 D●●: 3 poles + 1 N/O auxiliary contact + 1 N/C auxiliary contact

(3) Replace ●● with the control circuit voltage reference given in the table below:

	Volts ~	220	230	240
LC1K	50/60 Hz	M7	P7	U7
	Volts ~	220/230	230	230/240
LC1D	50 Hz	M5	P5	U5
	60 Hz	M6	–	U6
	50/60 Hz	M7	P7	U7

For other available voltages between 24 V and 660 V, or a DC control circuit, please contact our Customer Care Centre.

Protection using class J fuses (UL certification)

Servo drive Reference	Nominal power		Fuse to be placed upstream (A)
	kW	hp	
Mains supply voltage: 200...240 VAC 50/60Hz			
LXM28AUA5M3X, LXM28EUA5M3X	0.05	0.067	5
LXM28AU01M3X, LXM28EU01M3X	0.1	0.13	5
LXM28AU02M3X, LXM28EU02M3X	0.2	0.26	5
LXM28AU04M3X, LXM28EU04M3X	0.4	0.53	20
LXM28AU07M3X, LXM28EU07M3X	0.75	1.00	20
LXM28AU10M3X, LXM28EU10M3X	1	1.34	25
LXM28AU15M3X, LXM28EU15M3X	1.5	2.01	40
LXM28AU20M3X, LXM28EU20M3X	2	2.68	60
LXM28AU30M3X, LXM28EU30M3X	3	4.02	80
LXM28AU45M3X, LXM28EU45M3X	4.5	6.03	160

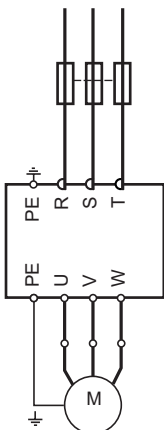

Lexium 28 servo drive + BCH2 servo motor with fuse protection



BCH2 with free leads connection



BCH2 servo motor with MIL connectors

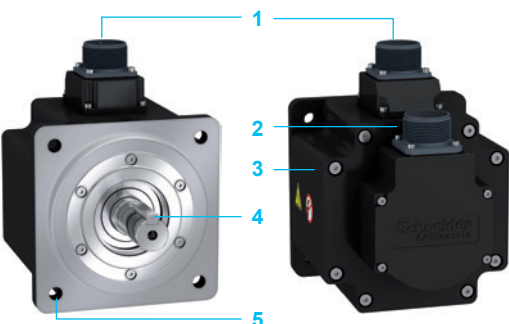

BCH2 servo motors

Presentation

BCH2 motors are synchronous AC servo motors.

- They are equipped as standard with a high-resolution (20-bit) single-turn or multi-turn absolute encoder. They are therefore ideal for high performance applications such as material working, machine tools, etc.
- BCH2 motors are available in six flange sizes: 40 mm (1.58 in.), 60 mm (2.36 in.), 80 mm (3.15 in.), 100 mm (3.94 in.), 130 mm (5.12 in.), and 180 mm (7.08 in.).
- Depending on flange size, the BCH2 motors are supplied with:
 - free leads with connectors
 - or MIL connectors
- BCH2 motors are available with holding brake.
- With the three available types of motor inertia, ranging from low to high inertia, the servo motors can be used in a very wide variety of installations:
 - low inertia: power between 0.2 kW and 1 kW (0.26 hp and 1.34 hp), suitable for textile and packaging applications.
 - medium inertia: power between 0.05 kW and 7,5 kW (0,067 hp and 10,06 hp), suitable for material working and machine tool applications.
 - high inertia: 0.75 kW (1.00 hp) power, suitable for metal working and printing applications.

Examples of applications according to motor inertia type:

Type of machine	Inertia		
	Low	Medium	High
Conveyors		✓	✓
Packaging machines	✓	✓	
Printers		✓	✓
Loaders/unloaders			✓
Presses			✓
PCB drilling machines	✓		
Electronic card testers	✓		
Labelling machines	✓		
Knitting and embroidery machines		✓	✓
Special machines		✓	✓
Winders/unwinders		✓	

Holding brake

BCH2 servo motors can be equipped with an electromagnetic holding brake.

⚠ Do not use the holding brake as a dynamic brake for deceleration, as this will quickly damage the brake.

Integrated encoder

BCH2 servo motors are equipped with a 20-bit single-turn or a multi-turn absolute encoder.

- The encoders measure the motor angular position with a precision of ± 2.6 arc minutes. The multi-turn absolute encoder also measures the number of motor turns.
- The absolute encoders perform the following functions:
 - providing the absolute position of the motor so that flows can be synchronized
 - measuring the servo motor speed via the associated Lexium 28 servo drive (this information is used by the servo drive's position and speed controller)
 - sending data from the servo motor to the servo drive, it provides automatic identification of the motor when the servo drive starts.

Description

BCH2 servo motors, with a 3-phase stator and a rotor with rare earth based permanent magnets, consist of:

- 1 Connector for the power cable
- 2 Connector for the encoder cable
- 3 Casing with RAL 9005 opaque black paint coating
- 4 Smooth or keyed shaft end (depending on the model)
- 5 4-point axial mounting flange (Flange is mechanically compatible for mounting with Asian style servo motors).

BCH2 servo motors													
To order a BCH2 servo motor, make up the reference as follows:													
Brushless servo motor	B	C	H	2	•	•	••	•	•	•	•	•	C
Inertia	Low inertia				L								
	Medium inertia				M								
	High inertia				H								
Flange size	40 mm (1.58 in.)					B							
	60 mm (2.36 in.)					D							
	80 mm (3.15 in.)					F							
	100 mm (3.94 in.)					H							
	130 mm (5.12 in.)					M							
	180 mm (7.08 in.)					R							
Rated output	50 W (0.067 hp)						A5						
	100 W (0.13 hp)						01						
	200 W (0.26 hp)						02						
	300 W (0.41 hp)						03						
	400 W (0.53 hp)						04						
	500 W (0.67 hp)						05						
	600 W (0.80 hp)						06						
	750 W (1.00 hp)						07						
	850 W (1.13 hp)						08						
	1 kW (1.34 hp)						10						
	1.5 kW (2.01 hp)						15						
	2 kW (2.68 hp)						20						
	3 kW (4.02 hp)						30						
3.5 kW (4.69 hp)						35							
4.5 kW (6.03 hp)						45							
Nominal speed	1000/1500 rpm							1					
	2000 rpm							2					
	3000 rpm							3					
Shaft end	Smooth shaft (shaft IP 54; housing IP 65) (1)								0				
	Keyed shaft (shaft IP 54; housing IP 65) (1)								1				
	Smooth shaft (shaft & housing IP 65)								2				
	Keyed shaft (shaft & housing IP 65)								3				
Encoder	High resolution single-turn absolute encoder, 20-bit resolution									C			
	High resolution multi-turn absolute encoder, 20 bit resolution, 4096 turns (2)									M			
Holding brake	Without brake										A		
	With brake (option)										F		
Connections	Free leads with connectors (BCH2•B/•D/•F motors only)											5	
	MIL connectors (BCH2•H/•M/•R motors only)											6	
Mechanical motor design	Motor compatible with Asian style mounting standards												C

(1) This type is not included in the range of BCH2 motors with multi-turn encoder.

(2) For motors equipped with multi-turn encoder, customer must order related battery accessory, reference: VW3M8BATC and VW3M9BATT..



Connection components for BCH2 motors

Cables and connectors to be ordered separately, for connection to Lexium 28 servo drives.

Schneider Electric has taken particular care over the compatibility of BCH2 servo motors and Lexium 28 servo drives.

This compatibility is only possible when using cables and connectors sold by Schneider Electric. See pages 20 and 21

Accessories for BCH2 motors

	Designation	Use	Reference	Weight kg/lb
	Battery compartment	For BCH2 motors with multi-turn absolute encoder	VW3M8BATC	0.100/0.220
	Battery 3.6 V	For BCH2 motors with multi-turn absolute encoder and battery compartment VW3M8BATC	VW3M9BATT	0.050/0.110

VW3M9BATT

BCH2 servo motors											
Dimensions and weight											
Servo motor	Pn	Flange		Dimensions (overall)				Weight			
				Servo motor without brake		Servo motor with brake		without brake		with brake	
				Width x Height x Depth (W x H x D)				Width x Height x Depth (W x H x D)			
W	mm	in.	mm	in.	mm	in.	kg	lb	kg	lb	
BCH2MBA53●●●5C	50	40	1.57	40 x 58.5 x 82	1.57 x 2.30 x 3.23	40 x 58.5 x 112	1.57 x 2.30 x 4.41	0.400	0.88	0.600	1.32
BCH2MB013●●●5C	100	40	1.57	40 x 58.5 x 100	1.57 x 2.30 x 3.94	40 x 58.5 x 130	1.57 x 2.30 x 5.12	0.560	1.23	0.770	1.70
BCH2LD023●●●5C	200	60	2.36	60 x 78.5 x 104	2.36 x 3.09 x 4.09	60 x 78.5 x 140	2.36 x 3.09 x 5.51	1.020	2.25	1.500	3.31
BCH2LD043●●●5C	400	60	2.36	60 x 78.5 x 129	2.36 x 3.09 x 5.08	60 x 78.5 x 165	2.36 x 3.09 x 6.50	1.450	3.20	2.000	4.41
BCH2LF043●●●5C	400	80	3.15	80 x 98.5 x 112	3.15 x 3.88 x 4.41	80 x 98.5 x 152	3.15 x 3.88 x 4.41	2.000	4.41	2.800	6.17
BCH2HF073●●●5C	750	80	3.15	80 x 98.5 x 138	3.15 x 3.88 x 5.43	80 x 98.5 x 178	3.15 x 3.88 x 7.01	2.900	6.39	3.700	8.16
BCH2LF073●●●5C	750	80	3.15	80 x 98.5 x 138	3.15 x 3.88 x 5.43	80 x 98.5 x 178	3.15 x 3.88 x 7.01	2.800	6.17	3.600	7.94
BCH2LH103●●●6C	1000	100	3.94	100 x 145.6 x 153.5	3.94 x 5.73 x 6.04	100 x 145.6 x 180.5	3.94 x 5.73 x 7.11	4.600	10.14	5.100	11.24
BCH2LH203●●●6C	2000	100	3.94	100 x 145.6 x 198.5	3.94 x 5.73 x 7.81	100 x 145.6 x 225.5	3.94 x 5.73 x 8.88	6.700	14.77	7.200	15.87
BCH2MM031●●●6C	300	130	5.12	130 x 176 x 147	5.12 x 6.92 x 5.79	130 x 176 x 183	5.12 x 6.92 x 7.20	7.000	15.43	8.200	18.08
BCH2MM052●●●6C	500	130	5.12	130 x 176 x 147	5.12 x 6.92 x 5.79	130 x 176 x 183	5.12 x 6.92 x 7.20	7.000	15.43	8.200	18.08
BCH2MM061●●●6C	600	130	5.12	130 x 176 x 147	5.12 x 6.92 x 5.79	130 x 176 x 183	5.12 x 6.92 x 7.20	7.000	15.43	8.200	18.08
BCH2MM081●●●6C	850	130	5.12	130 x 176 x 187	5.12 x 6.92 x 7.36	130 x 176 x 216	5.12 x 6.92 x 8.50	9.600	21.16	10.900	24.03
BCH2MM091●●●6C	900	130	5.12	130 x 176 x 163	5.12 x 6.92 x 6.42	130 x 176 x 198	5.12 x 6.92 x 7.80	7.600	16.76	8.800	19.40
BCH2MM102●●●6C	1000	130	5.12	130 x 176 x 147	5.12 x 6.92 x 5.79	130 x 176 x 183	5.12 x 6.92 x 7.20	7.000	15.43	8.200	18.08
BCH2HM102●●●6C	1000	130	5.12	130 x 176 x 147	5.12 x 6.92 x 5.79	130 x 176 x 176	5.12 x 6.92 x 6.92	7.000	15.43	8.200	18.08
BCH2MM152●●●6C	1500	130	5.12	130 x 176 x 167	5.12 x 6.92 x 6.57	130 x 176 x 202	5.12 x 6.92 x 7.95	7.600	16.76	8.800	19.40
BCH2MM202●●●6C	2000	130	5.12	130 x 176 x 187	5.12 x 6.92 x 7.36	130 x 176 x 216	5.12 x 6.92 x 8.50	9.700	21.38	11.000	24.25
BCH2MR202●●●6C	2000	180	7.09	180 x 245 x 169	7.09 x 9.65 x 6.65	180 x 245 x 203	7.09 x 9.65 x 7.99	13.000	28.66	18.000	39.68
BCH2HR202●●●6C	2000	180	7.09	180 x 245 x 168	7.09 x 9.65 x 6.61	180 x 245 x 203	7.09 x 9.65 x 7.99	13.000	28.66	18.000	39.68
BCH2MR301●●●6C	3000	180	7.09	180 x 245 x 202	7.09 x 9.65 x 7.95	180 x 245 x 235	7.09 x 9.65 x 9.25	18.500	40.79	23.000	50.71
BCH2MR302●●●6C	3000	180	7.09	180 x 245 x 202	7.09 x 9.65 x 7.95	180 x 245 x 235	7.09 x 9.65 x 9.25	18.500	40.79	23.000	50.71
BCH2MR352●●●6C	3500	180	7.09	180 x 245 x 202	7.09 x 9.65 x 7.95	180 x 245 x 235	7.09 x 9.65 x 9.25	18.500	40.79	23.000	50.71
BCH2MR451●●●6C	4500	180	7.09	180 x 245 x 235	7.09 x 9.65 x 9.25	180 x 245 x 279	7.09 x 9.65 x 10.98	23.640	52.12	28.000	61.73

●●●: Please refer to the type code table on page 17

Lexium 28 & Motors

BCH2 servo motors

Options: holding brake, integrated encoder

Option: GBX●●●●●K planetary gearboxes

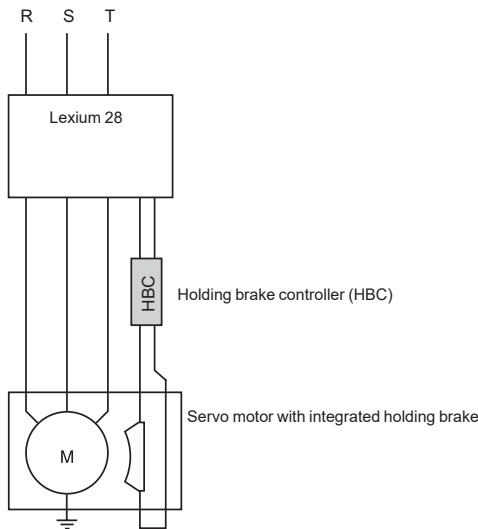

Holding brake

Presentation

If a servo motor has a holding brake, it is necessary to give an appropriate control logic (HBC, Holding Brake Controller), which releases the brake when power is supplied to the servo motor and immobilizes the servo motor shaft when it is stationary.

The holding brake controller amplifies the braking control signal (Digital output) transmitted by the Lexium 28 servo drive, so that the brake is deactivated quickly. It then reduces this control signal so as to decrease the power dissipated by the holding brake.



VW3M3103

References

Designation	Description	Reference	Weight kg/lb
Holding brake controller	<input type="checkbox"/> 24 V $\overline{\text{DC}}$ power supply <input type="checkbox"/> Max. power 50 W (0.06 hp) <input type="checkbox"/> IP 20 <input type="checkbox"/> for mounting on 55 mm (2.17 in) \perp rail	VW3M3103	0.600/ 1.323

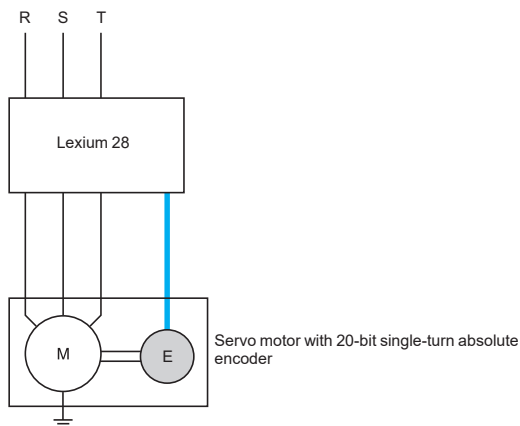

Integrated encoder in BCH2 servo motors

Presentation

The standard measurement device is a 20-bit single-turn absolute encoder integrated in BCH2 servo motors. This measurement device is particularly suited to the Lexium 28 range of servo drives.

Use of this interface enables:

- Automatic identification of BCH2 servo motor data by the servo drive
- Automatic initialization of the servo drive control loops, thus simplifying installation and drive commissioning at the machine

GBX planetary gearboxes

Please refer to the catalog ref. [DIA3ED2160313EN](#) (Press to open the catalog)



Lexium 28 & Motors

BCH2 servo motors

Connection components

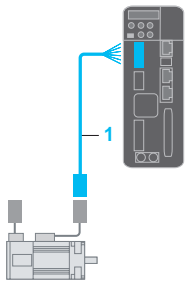

VW3M5D1●R●●

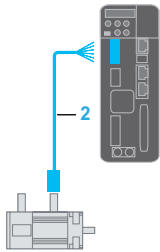

VW3M5D2●R●●
VW3M5D4●R●●
VW3M5D6●R●●

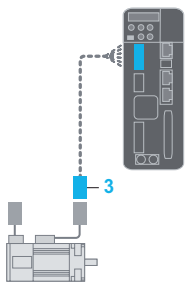

VW3M5D1●

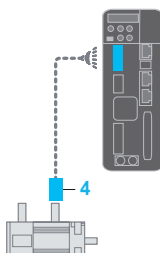

VW3M5D2●

Connection components for BCH2 servo motors

Power cable type

Connector	AWG	mm ²	Length m/ft	Reference	Weight kg/lb
-----------	-----	-----------------	-------------	-----------	--------------

Shielded power cordsets for BCH2 motors without brake

Equipped with one quick connector (servo motor side), and open end (servo drive side) (item 1)	AWG18	4x 0.82..1.0	1.5 / 4.92	VW3M5D1AR15	0.200 / 0.441
			3 / 9.84	VW3M5D1AR30	0.300 / 0.661
			5 / 16.40	VW3M5D1AR50	0.450 / 0.992

Equipped with one MIL connector (servo motor side), and open end (servo drive side) (item 2)	AWG16	4x 1.3..1.5	3 / 9.84	VW3M5D2AR30	0.450 / 0.992
			5 / 16.40	VW3M5D2AR50	0.700 / 1.543

AWG12	4x 3.3..4.0	3 / 9.84	VW3M5D4AR30	0.750 / 1.653
		5 / 16.40	VW3M5D4AR50	1.250 / 2.756

AWG10	4x 6.0	3 / 9.84	VW3M5D6AR30	2.100 / 4.630
		5 / 16.40	VW3M5D6AR50	3.400 / 7.496

Shielded power cordsets for BCH2 motors with brake

Equipped with one quick connector (servo motor side), and open end (servo drive side) (item 1)	AWG18	6x 0.82..1.0	3 / 9.84	VW3M5D1FR30	0.300 / 0.661
			5 / 16.40	VW3M5D1FR50	0.450 / 0.992

Equipped with one MIL connector (servo motor side), and a free lead (servo drive side) (item 2)	AWG16	6x 1.3..1.5	3 / 9.84	VW3M5D2FR30	0.650 / 1.433
			5 / 16.40	VW3M5D2FR50	0.900 / 1.984

AWG12	6x 3.3..4.0	3 / 9.84	VW3M5D4FR30	0.950 / 2.094
		5 / 16.40	VW3M5D4FR50	1.450 / 3.197

AWG10	6x 6.0	3 / 9.84	VW3M5D6FR30	3.000 / 6.614
		5 / 16.40	VW3M5D6FR50	5.000 / 11.023

Motor power connectors kits

Description	Use	Unit reference	Weight kg/lb
-------------	-----	----------------	--------------

Motor power connector kits (sold in lots of 3) (item 3)	BCH2●B/●D/●F motors (flange size: 40/60/80 mm) with free leads connection, without brake	VW3M5D1A	0.150 / 0.331
---	--	----------	---------------

BCH2●B/●D/●F motors (flange size: 40/60/80 mm) with free leads connection, with brake	VW3M5D1F	0.150 / 0.331
---	----------	---------------

Power MIL connector kits (item 4)	BCH2●H/●M motors (flange size: 100/130 mm) with or without brake	VW3M5D2A	0.300 / 0.661
-----------------------------------	--	----------	---------------

BCH2●R motors (flange size: 180mm) with or without brake	VW3M5D2B	0.300 / 0.661
--	----------	---------------

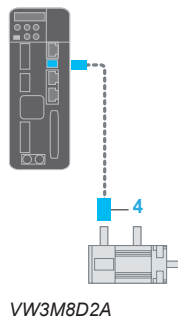
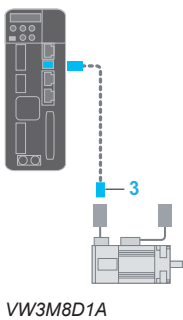
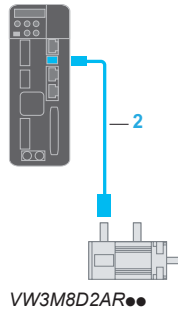
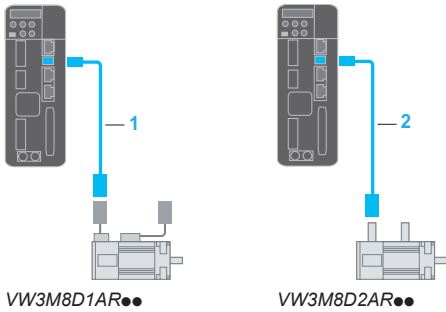

Connection components for BCH2 servo motors

Description	Use	Composition	Length m/ft	Reference	Weight kg/lb
Shielded encoder cordsets					
Equipped with a connector at both ends (item 1)	For BCH2●B/●D/●F motors, for connection on CN2 interface	10x 0.13 mm ²	1.5/4.92	VW3M8D1AR15	0.500/1.102
			3/9.84	VW3M8D1AR30	1.000/2.205
			5/16.40	VW3M8D1AR50	1.200/2.646
Equipped with one MIL connector (servo motor side), and a firewire connector (servo drive side) (item 2)	For BCH2●H/●M/●R, for connection on CN2 interface	10x 0.13 mm ²	3/9.84	VW3M8D2AR30	1.300/2.866
			5/16.40	VW3M8D2AR50	1.500/3.307

Encoder connector kits

Encoder connector kits	For BCH2●B/●D/●F motors (flange: 40/60/80 mm) with free leads connection (item 3) (sold in lots of 3)	VW3M8D1A	0.150/0.331
	For BCH2●H/●M/●R motors (flange: 100/130/180 mm) with MIL connector (item 4) (sold in lots of 1)	VW3M8D2A	0.150/0.331

Selection of motor connector kit, or encoder connector kit, according to BCH2 motor type

Motor	Motor power cable connector kit		Encoder connector kit	Motor power cable		Encoder cable
	Without brake	With brake		Without brake	With brake	
BCH2MBA53●●●5C	VW3M5D1A	VW3M5D1F	VW3M8D1A	VW3M5D1AR15 VW3M5D1AR30 VW3M5D1AR50	VW3M5D1FR30 VW3M5D1FR50	VW3M8D1AR15 VW3M8D1AR30 VW3M8D1AR50
BCH2MB013●●●5C						
BCH2LD023●●●5C						
BCH2LD043●●●5C						
BCH2LF043●●●5C						
BCH2HF073●●●5C						
BCH2LF073●●●5C						
BCH2LH103●●●6C						
BCH2LH203●●●6C						
BCH2MM081●●●6C						
BCH2MM031●●●6C	VW3M5D2A	VW3M5D2A	VW3M8D2A	VW3M5D2AR30 VW3M5D2AR50	VW3M5D2FR30 VW3M5D2FR50	VW3M8D2AR30 VW3M8D2AR50
BCH2MM052●●●6C						
BCH2MM061●●●6C						
BCH2MM102●●●6C						
BCH2HM102●●●6C						
BCH2MM091●●●6C						
BCH2MM152●●●6C						
BCH2MM202●●●6C						
BCH2MR202●●●6C						
BCH2HR202●●●6C						
BCH2MR301●●●6C	VW3M5D2B	VW3M5D2B	VW3M8D2A	VW3M5D4AR30 VW3M5D4AR50	VW3M5D4FR30 VW3M5D4FR50	VW3M8D2AR30 VW3M8D2AR50
BCH2MR302●●●6C						
BCH2MR352●●●6C						
BCH2MR451●●●6C						
BCH2MR302●●●6C				VW3M5D6AR30 VW3M5D6AR50	VW3M5D6FR30 VW3M5D6FR50	

Lexium 28 & Motors

Lexium 28 servo drives and BCH2 servo motors
Product reference index

4	BCH2LD0433CF5C	17	BCH2MB0133CF5C	17	BCH2MM0813CF6C	17	BCH2MR2023CF6C	17	
490NTC00005	13	BCH2LD0433MA5C	17	BCH2MB0133MA5C	17	BCH2MM0813MA6C	17	BCH2MR2023MA6C	17
490NTC00005U	13	BCH2LD0433MF5C	17	BCH2MB0133MF5C	17	BCH2MM0813MF6C	17	BCH2MR2023MF6C	17
490NTC00015	13	BCH2LF0430CA5C	17	BCH2MBA530CA5C	17	BCH2MM0910CA6C	17	BCH2MR3010CA6C	17
490NTW00002	13	BCH2LF0430CF5C	17	BCH2MBA530CF5C	17	BCH2MM0910CF6C	17	BCH2MR3010CF6C	17
490NTW00002U	13	BCH2LF0431CA5C	17	BCH2MBA531CA5C	17	BCH2MM0911CA6C	17	BCH2MR3011CA6C	17
490NTW00005	13	BCH2LF0431CF5C	17	BCH2MBA531CF5C	17	BCH2MM0911CF6C	17	BCH2MR3011CF6C	17
490NTW00005U	13	BCH2LF0432CA5C	17	BCH2MBA532CA5C	17	BCH2MM0912CA6C	17	BCH2MR3012CA6C	17
490NTW00012	13	BCH2LF0432CF5C	17	BCH2MBA532CF5C	17	BCH2MM0912CF6C	17	BCH2MR3012CF6C	17
490NTW00012U	13	BCH2LF0432MA5C	17	BCH2MBA532MA5C	17	BCH2MM0912MA6C	17	BCH2MR3012MA6C	17
		BCH2LF0432MF5C	17	BCH2MBA532MF5C	17	BCH2MM0912MF6C	17	BCH2MR3012MF6C	17
B		BCH2LF0433CA5C	17	BCH2MBA533CA5C	17	BCH2MM0913CA6C	17	BCH2MR3013CA6C	17
BCH2HF0730CA5C	17	BCH2LF0433CF5C	17	BCH2MBA533CF5C	17	BCH2MM0913CF6C	17	BCH2MR3013CF6C	17
BCH2HF0730CF5C	17	BCH2LF0433MA5C	17	BCH2MBA533MA5C	17	BCH2MM0913MA6C	17	BCH2MR3013MA6C	17
BCH2HF0731CA5C	17	BCH2LF0433MF5C	17	BCH2MBA533MF5C	17	BCH2MM0913MF6C	17	BCH2MR3013MF6C	17
BCH2HF0731CF5C	17	BCH2LF0730CA5C	17	BCH2MM0310CA6C	17	BCH2MM1020CA6C	17	BCH2MR3020CA6C	17
BCH2HF0732CA5C	17	BCH2LF0730CF5C	17	BCH2MM0310CF6C	17	BCH2MM1020CF6C	17	BCH2MR3020CF6C	17
BCH2HF0732CF5C	17	BCH2LF0730MA5C	17	BCH2MM0311CA6C	17	BCH2MM1021CA6C	17	BCH2MR3021CA6C	17
BCH2HF0732MA5C	17	BCH2LF0731CA5C	17	BCH2MM0311CF6C	17	BCH2MM1021CF6C	17	BCH2MR3021CF6C	17
BCH2HF0732MF5C	17	BCH2LF0731CF5C	17	BCH2MM0311CF6C	17	BCH2MM1021CF6C	17	BCH2MR3021CF6C	17
BCH2HF0732MA5C	17	BCH2LF0732CA5C	17	BCH2MM0312CA6C	17	BCH2MM1022CA6C	17	BCH2MR3022CA6C	17
BCH2HF0732MF5C	17	BCH2LF0732CF5C	17	BCH2MM0312CF6C	17	BCH2MM1022CF6C	17	BCH2MR3022CF6C	17
BCH2HF0733CA5C	17	BCH2LF0732MA5C	17	BCH2MM0312MA6C	17	BCH2MM1022MA6C	17	BCH2MR3022MA6C	17
BCH2HF0733CF5C	17	BCH2LF0732MF5C	17	BCH2MM0312MF6C	17	BCH2MM1022MF6C	17	BCH2MR3022MF6C	17
BCH2HF0733MA5C	17	BCH2LF0733CA5C	17	BCH2MM0313CA6C	17	BCH2MM1023CA6C	17	BCH2MR3023CA6C	17
BCH2HF0733CF5C	17	BCH2LF0733CF5C	17	BCH2MM0313CF6C	17	BCH2MM1023CF6C	17	BCH2MR3023CF6C	17
BCH2HF0733MA5C	17	BCH2LF0733MA5C	17	BCH2MM0313MA6C	17	BCH2MM1023MA6C	17	BCH2MR3023MA6C	17
BCH2HF0733MF5C	17	BCH2LF0733MF5C	17	BCH2MM0313MF6C	17	BCH2MM1023MF6C	17	BCH2MR3023MF6C	17
BCH2HM1022CA6C	17	BCH2LH1030CA6C	17	BCH2MM0520CA6C	17	BCH2MM1520CA6C	17	BCH2MR3520CA6C	17
BCH2HM1022CF6C	17	BCH2LH1030CF6C	17	BCH2MM0520CF6C	17	BCH2MM1520CF6C	17	BCH2MR3520CF6C	17
BCH2HM1022MA6C	17	BCH2LH1031CA6C	17	BCH2MM0521CA6C	17	BCH2MM1521CA6C	17	BCH2MR3521CA6C	17
BCH2HM1022MF6C	17	BCH2LH1031CF6C	17	BCH2MM0521CF6C	17	BCH2MM1521CF6C	17	BCH2MR3521CF6C	17
BCH2HM1023CA6C	17	BCH2LH1032CA6C	17	BCH2MM0522CA6C	17	BCH2MM1522CA6C	17	BCH2MR3522CA6C	17
BCH2HM1023CF6C	17	BCH2LH1032CF6C	17	BCH2MM0522CF6C	17	BCH2MM1522CF6C	17	BCH2MR3522CF6C	17
BCH2HM1023MA6C	17	BCH2LH1032MA6C	17	BCH2MM0522MA6C	17	BCH2MM1522MA6C	17	BCH2MR3522MA6C	17
BCH2HM1023MF6C	17	BCH2LH1032MF6C	17	BCH2MM0522MF6C	17	BCH2MM1522MF6C	17	BCH2MR3522MF6C	17
BCH2HR2022CA6C	17	BCH2LH1033CA6C	17	BCH2MM0523CA6C	17	BCH2MM1523CA6C	17	BCH2MR3523CA6C	17
BCH2HR2022CF6C	17	BCH2LH1033CF6C	17	BCH2MM0523CF6C	17	BCH2MM1523CF6C	17	BCH2MR3523CF6C	17
BCH2HR2022MA6C	17	BCH2LH1033MA6C	17	BCH2MM0523MA6C	17	BCH2MM1523MA6C	17	BCH2MR3523MA6C	17
BCH2HR2022MF6C	17	BCH2LH1033MF6C	17	BCH2MM0523MF6C	17	BCH2MM1523MF6C	17	BCH2MR3523MF6C	17
BCH2HR2023CA6C	17	BCH2LH2030CA6C	17	BCH2MM0610CA6C	17	BCH2MM2020CA6C	17	BCH2MR4510CA6C	17
BCH2HR2023CF6C	17	BCH2LH2030CF6C	17	BCH2MM0610CF6C	17	BCH2MM2020CF6C	17	BCH2MR4510CF6C	17
BCH2HR2023MA6C	17	BCH2LH2031CA6C	17	BCH2MM0611CA6C	17	BCH2MM2021CA6C	17	BCH2MR4511CA6C	17
BCH2HR2023MF6C	17	BCH2LH2031CF6C	17	BCH2MM0611CF6C	17	BCH2MM2021CF6C	17	BCH2MR4511CF6C	17
BCH2LD0230CA5C	17	BCH2LH2032CA6C	17	BCH2MM0612CA6C	17	BCH2MM2022CA6C	17	BCH2MR4512CA6C	17
BCH2LD0230CF5C	17	BCH2LH2032CF6C	17	BCH2MM0612CF6C	17	BCH2MM2022CF6C	17	BCH2MR4512CF6C	17
BCH2LD0231CA5C	17	BCH2LH2032MA6C	17	BCH2MM0612MA6C	17	BCH2MM2022MA6C	17	BCH2MR4512MA6C	17
BCH2LD0231CF5C	17	BCH2LH2032MF6C	17	BCH2MM0612MF6C	17	BCH2MM2022MF6C	17	BCH2MR4512MF6C	17
BCH2LD0232CA5C	17	BCH2LH2033CA6C	17	BCH2MM0613CA6C	17	BCH2MM2023CA6C	17	BCH2MR4513CA6C	17
BCH2LD0232CF5C	17	BCH2LH2033CF6C	17	BCH2MM0613CF6C	17	BCH2MM2023CF6C	17	BCH2MR4513CF6C	17
BCH2LD0232MA5C	17	BCH2LH2033MA6C	17	BCH2MM0613MA6C	17	BCH2MM2023MA6C	17	BCH2MR4513MA6C	17
BCH2LD0232MF5C	17	BCH2LH2033MF6C	17	BCH2MM0613MF6C	17	BCH2MM2023MF6C	17	BCH2MR4513MF6C	17
BCH2LD0233CA5C	17	BCH2MB0130CA5C	17	BCH2MM0810CA6C	17	BCH2MR2020CA6C	17	BCH2MR5512CA6C	17
BCH2LD0233CF5C	17	BCH2MB0130CF5C	17	BCH2MM0810CF6C	17	BCH2MR2020CF6C	17	BCH2MR5512CF6C	17
BCH2LD0233MA5C	17	BCH2MB0131CA5C	17	BCH2MM0811CA6C	17	BCH2MR2021CA6C	17	BCH2MR5512MA6C	17
BCH2LD0233MF5C	17	BCH2MB0131CF5C	17	BCH2MM0811CF6C	17	BCH2MR2021CF6C	17	BCH2MR5512MF6C	17
BCH2LD0233MA5C	17	BCH2MB0132CA5C	17	BCH2MM0812CA6C	17	BCH2MR2022CA6C	17	BCH2MR5513CA6C	17
BCH2LD0233CF5C	17	BCH2MB0132CF5C	17	BCH2MM0812CF6C	17	BCH2MR2022CF6C	17	BCH2MR5513CF6C	17
BCH2LD0233MA5C	17	BCH2MB0132MA5C	17	BCH2MM0812MA6C	17	BCH2MR2022MA6C	17	BCH2MR5513MA6C	17
BCH2LD0233MF5C	17	BCH2MB0132MF5C	17	BCH2MM0812MF6C	17	BCH2MR2022MF6C	17	BCH2MR5513MF6C	17
BCH2LD0430CA5C	17	BCH2MB0133CA5C	17	BCH2MM0813CA6C	17	BCH2MR2023CA6C	17	BCH2MR7512CA6C	17
BCH2LD0430CF5C	17								

BCH2MR7512CF6C	17
BCH2MR7512MA6C	17
BCH2MR7512MF6C	17
BCH2MR7513CA6C	17
BCH2MR7513CF6C	17
BCH2MR7513MA6C	17
BCH2MR7513MF6C	17

L

LXM28AU01M3X	6 8 15
LXM28AU02M3X	6 8 15
LXM28AU04M3X	6 8 15
LXM28AU07M3X	6 8 15
LXM28AU10M3X	6 8 15
LXM28AU15M3X	6 8 15
LXM28AU20M3X	6 8 15
LXM28AU30M3X	6 8 15
LXM28AU45M3X	6 8 15
LXM28AUA5M3X	6 8 15
LXM28EU01M3X	6 8 15
LXM28EU02M3X	6 8 15
LXM28EU04M3X	6 8 15
LXM28EU07M3X	6 8 15
LXM28EU10M3X	6 8 15
LXM28EU15M3X	6 8 15
LXM28EU20M3X	6 8 15
LXM28EU30M3X	6 8 15
LXM28EU45M3X	6 8 15
LXM28EUA5M3X	6 8 15

T

TCSCAR013M120	12
TCSMCNAM3M002P	10
TSXCANCA50	12

TSXCANCA100	12
TSXCANCA300	12
TSXCANCB50	12
TSXCANCB100	12
TSXCANCB300	12
TSXCANCD50	12
TSXCANCD100	12
TSXCANCD300	12

V

VW3A4420	14
VW3A4421	14
VW3A4422	14
VW3A4423	14
VW3A4424	14
VW3A4426	14
VW3A7602R07	11
VW3A7602R20	11
VW3A7602R30	11
VW3A7603R07	11
VW3A7603R20	11
VW3A7603R30	11
VW3A7604R07	11
VW3A7604R20	11
VW3A7604R30	11
VW3A7606R07	11
VW3A7606R20	11
VW3A7606R30	11
VW3A7607R07	11
VW3A7607R20	11
VW3A7607R30	11
VW3A7704	11
VW3A7705	11
VW3A8121	10
VW3A8126	10
VW3CANCARR1	12
VW3CANCARR03	12
VW3M1C10R10	9
VW3M1C10R20	9
VW3M1C10R30	9
VW3M1C12	9
VW3M1C13	9
VW3M1C20R10	9
VW3M1C20R20	9
VW3M1C20R30	9
VW3M4C21	9
VW3M4C23	9
VW3M4C24	9
VW3M5D1A	20
VW3M5D1AR15	20 21
VW3M5D1AR30	20 21
VW3M5D1AR50	20 21
VW3M5D1F	20
VW3M5D1FR30	20 21
VW3M5D1FR50	20 21
VW3M5D2A	20
VW3M5D2AR30	20 21

VW3M5D2AR50	20 21
VW3M5D2B	20
VW3M5D2FR30	20
VW3M5D2FR50	20
VW3M5D4AR30	20
VW3M5D4AR50	20
VW3M5D4FR30	20
VW3M5D4FR50	20
VW3M5D6AR30	20 21
VW3M5D6AR50	20 21
VW3M5D6FR30	20 21
VW3M5D6FR50	20 21
VW3M8BATC	17
VW3M8D1A	21
VW3M8D1AR15	21
VW3M8D1AR30	21
VW3M8D1AR50	21
VW3M8D2A	21
VW3M8D2AR30	21
VW3M8D2AR50	21
VW3M9BATT	17
VW3M2207	9
VW3M2501	9
VW3M3103	19
VW3M3805R010	12
VW3M3805R030	12
VW3M7101R01	9
VW3M7102R150	9



www.schneider-electric.com/msx

Schneider Electric Industries SAS

Head Office
35, rue Joseph Monier
F-92500 Rueil-Malmaison
France

The information provided in this documentation contains general descriptions and/or technical characteristics of the performance of the products contained herein. This documentation is not intended as a substitute for and is not to be used for determining suitability or reliability of these products for specific user applications. It is the duty of any such user or integrator to perform the appropriate and complete risk analysis, evaluation and testing of the products with respect to the relevant specific application or use thereof. Neither Schneider Electric nor any of its affiliates or subsidiaries shall be responsible or liable for misuse of the information contained herein.

Design: Schneider Electric
Photos: Schneider Electric